

TX-3535RGB4FC120-OGVCND34-02

PRODUCT SPECIFICATION

Features:

- ◆Excellent transiting heat from LED chip operating under 350mA
- ◆High luminous output
- ◆No UV

Chip Material:

- ◆Red: AlGaInP
- ◆Green: GaN
- ◆Blue: GaN

Lens Color:

- ◆Water clear

Applications:

- ◆Stage lighting
- ◆Garden lighting
- ◆Landscape Lighting

Part No.	TX-3535RGB4FC120-OGVCND34-02	Spec No.	WKF-BE0131	Page	1 of 9
----------	------------------------------	----------	------------	------	--------

Package Dimensions:

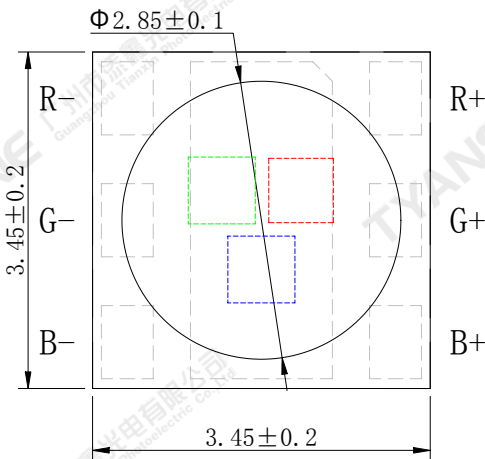

Top view

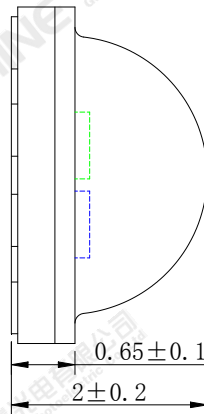

Side view

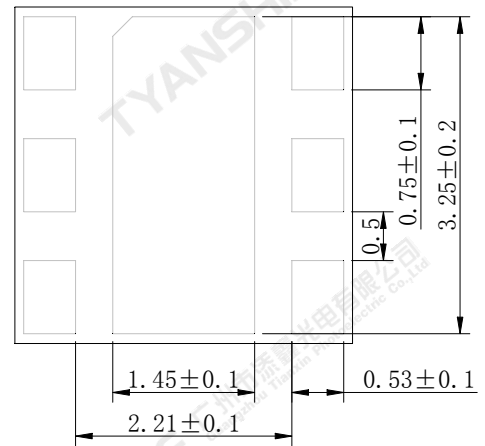

Bottom view

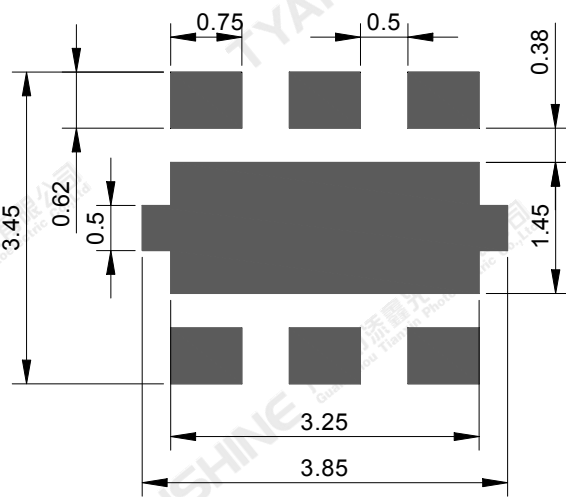

Recommended solder pad

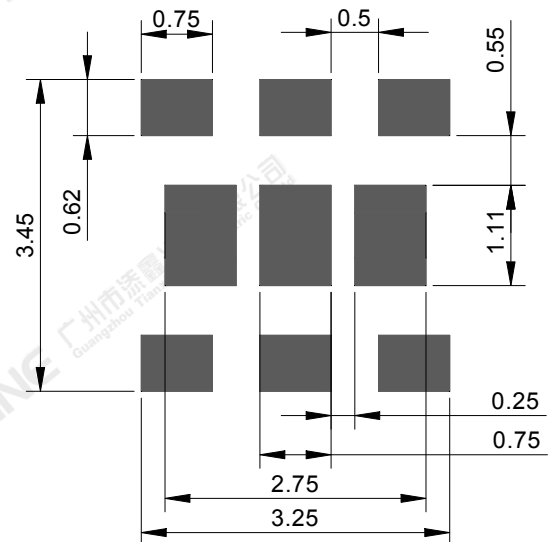

Recommended stencil pattern

Notes:

1. All dimensions are in millimeters .
2. Tolerances unless otherwise mentioned are ± 0.1 mm .

Part No.	TX-3535RGB4FC120-OGVCND34-02	Spec No.	WKF-BE0131	Page	2 of 9
----------	------------------------------	----------	------------	------	--------

Absolute Maximum Ratings (Tc=25°C)

Parameter	Symbol	Max Ratings	Unit
Forward Current	IF	400	mA
Reverse Voltage	VR	5	V
Power Dissipation	PD	R	875
		G	1225
		B	1225
Junction Temperature	Tj	R	115
		G	150
		B	150
Electrostatic Discharge Threshold (ESD)	ESD	2000	V
Storage Temperature	Tstg	-40~70	°C
Operation Temperature	Topr	-30~100	

Notes:

- Specifications are subject to change without notice.
- The data on this specification is for reference only and the actual data is in accordance with the acknowledgment.
- Precautions for ESD:
STATIC SHIELD Electricity and surge damages the LED. It is recommended to use a wrist band or anti-electrostatic glove when handling the LED. All devices, equipment and machinery must be properly grounded.

Electrical Optical Characteristics (Ta=25°C)

Parameter	Symbol	Condition	Emitting Color	Min.	Typ.	Max.	Units
Luminous Flux	ϕ_v	If=350mA	R	45	55	65	lm
			G	90	105	120	
			B	15	26	38	
Dominant Wavelength	λ_d		R	618	620	628	nm
			G	518	523	532	
			B	452	464	476	
Peak-emission Wavelength	λ_p		R	628	630	638	nm
			G	513	518	527	
			B	447	459	471	
Spectral Line Half-Width	$\Delta\lambda$	R	10	15	20	nm	
		G	19	24	29		
		B	30	35	40		
Forward Voltage	V_f	R	2.0	2.2	2.5	V	
		G	2.9	3.1	3.5		
		B	2.9	3.0	3.5		
Reverse Current	I_R	$V_R=7V$	R	—	—	5	μA
		G	—	—	5		
		B	—	—	5		
Viewing Angle at 50 % IV	$2\theta_{1/2}$	—	—	—	120	—	Deg
Thermal Resistance Junction to Case	$R\theta_{J-C}$	—	R	—	14	—	K/W
			G	—	14	—	
			B	—	14	—	
			Total thermal resistance	—	6.5	—	
Temperature Coefficient of Voltage	$V\Delta F/T$	If=350mA	R	—	-1.3	—	mV/°C
			G	—	-3.2	—	
			B	—	-3.1	—	

Notes:

- 1.Luminous intensity is measured with a light sensor and filter combination that approximates the CIE eye-response curve.
2. $\theta_{1/2}$ is the off-axis angle at which the luminous intensity is half the axial luminous intensity.
- 3.The dominant wavelength (λ_d) is derived from the CIE chromaticity diagram and represents the single wavelength which defines the color of the device.
- 4.Luminous flux measurement tolerance:±15%.
- 5.Forward voltage measurement tolerance:±0.15V.

Typical Electrical/Optical Characteristics Curves

(25°C Ambient Temperature Unless Otherwise Noted)

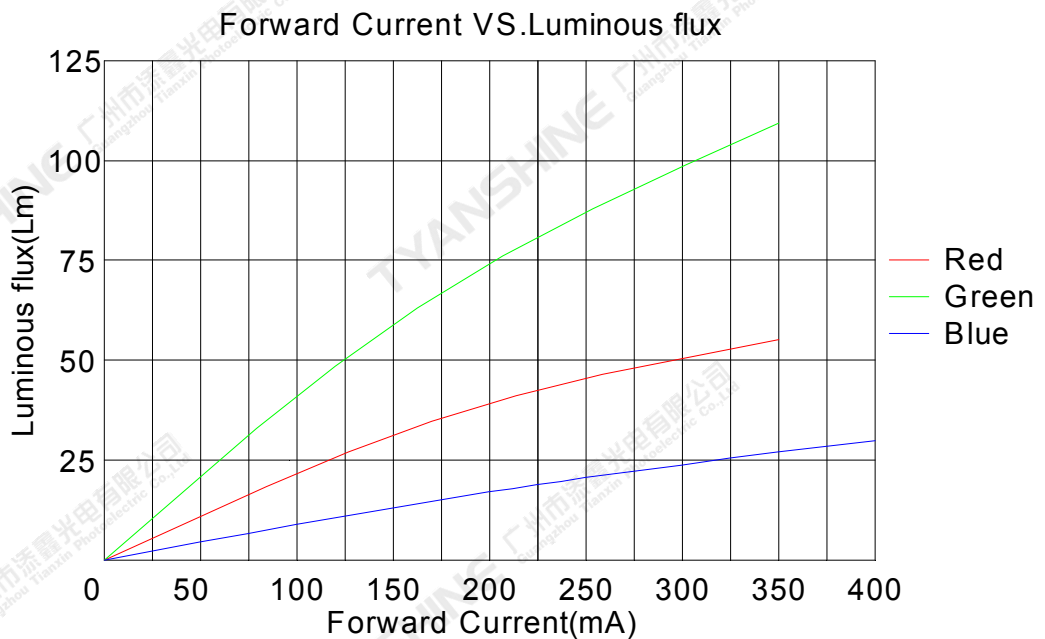
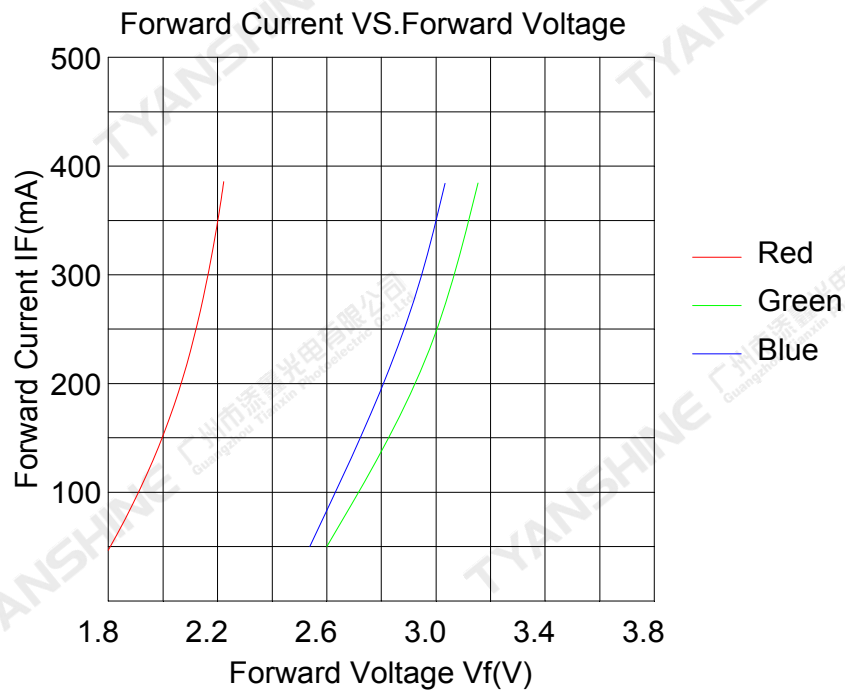

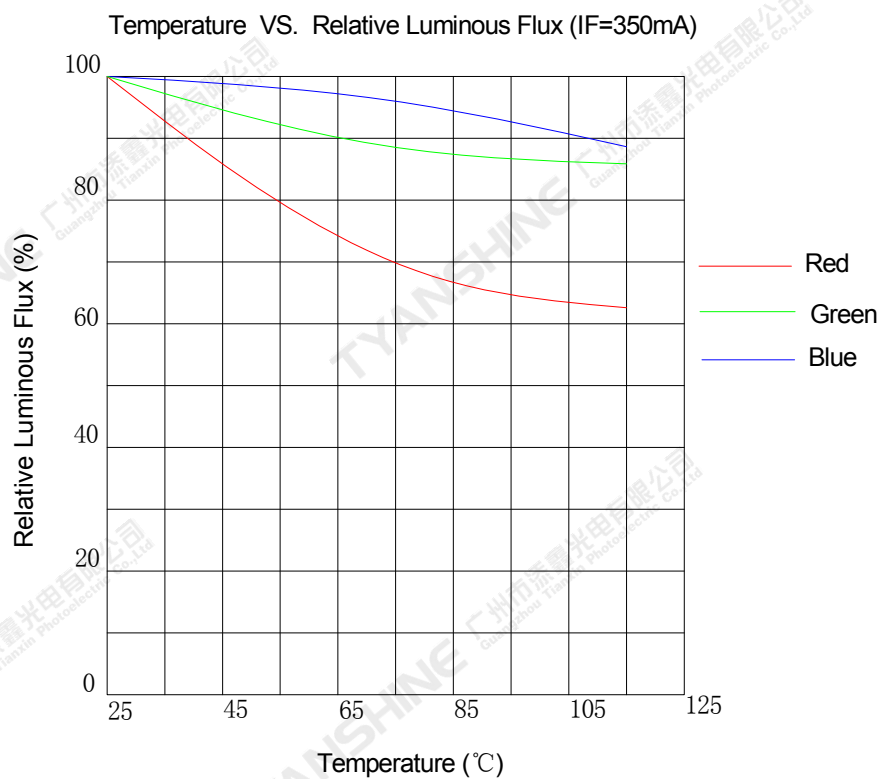
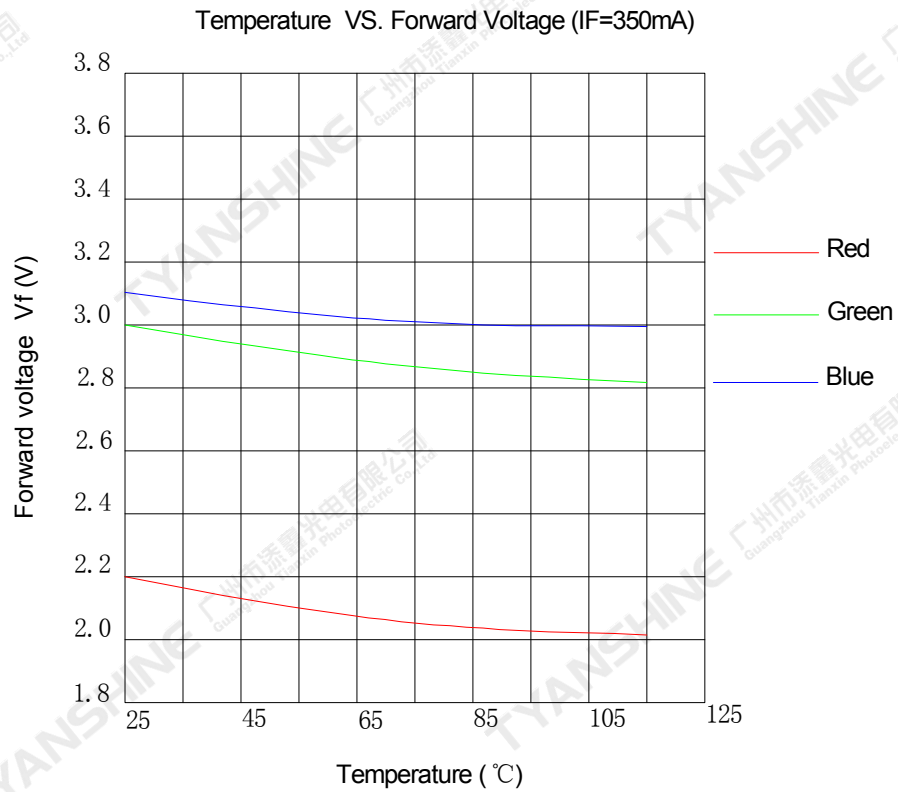

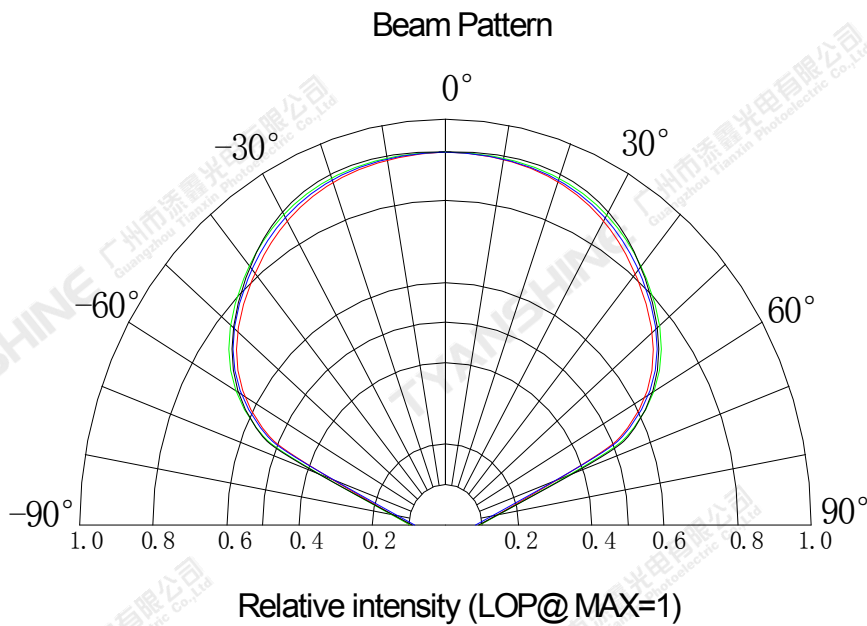
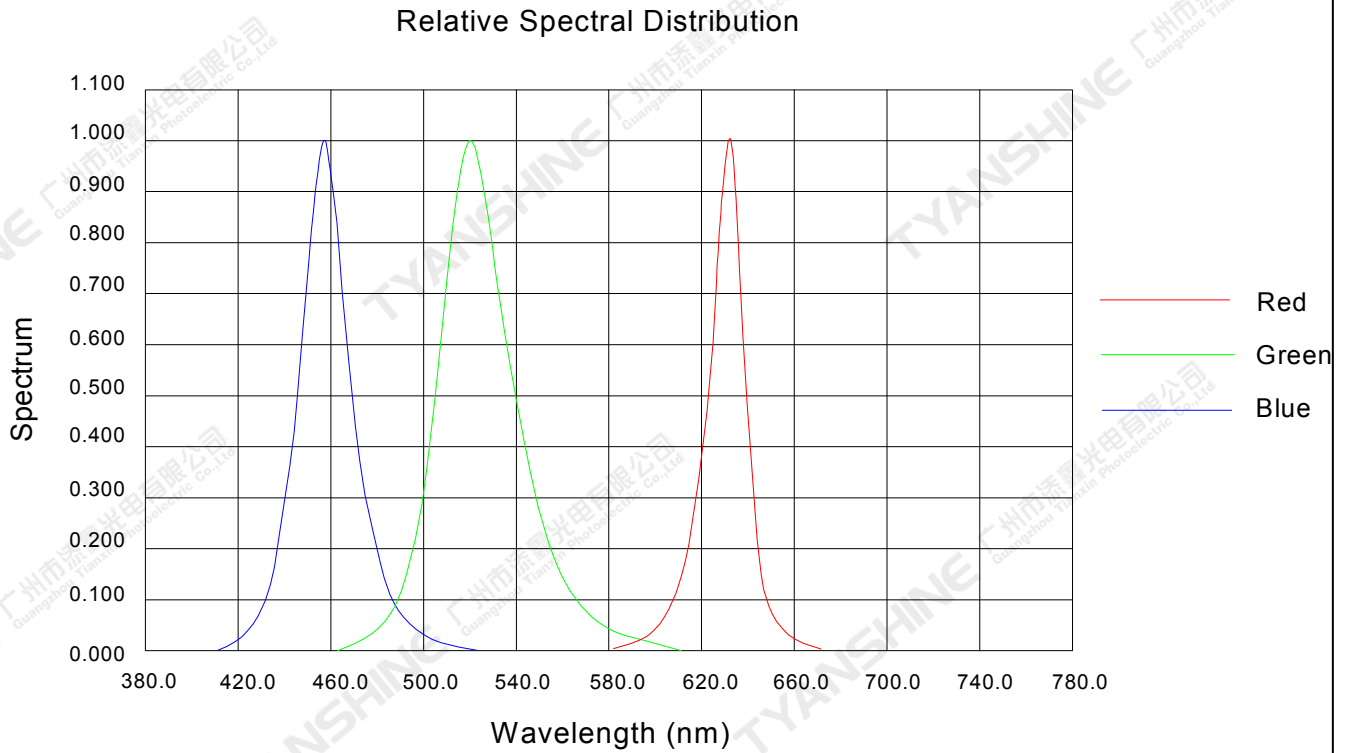

Notes:

1. $2\theta_{1/2}$ is the off axis angle from lamp centerline where the luminous intensity is 1/2 of the peak value.
2. View angle tolerance is $\pm 5^\circ$.

Part No.	TX-3535RGB4FC120-OGVCND34-02	Spec No.	WKF-BE0131	Page	7 of 9
----------	------------------------------	----------	------------	------	--------

Usage Precautions

Storage Environment Condition

Temperature: 5°C ~ 30°C (41°F ~ 86°F)

Humidity: 60% RH Max.

Soldering Condition

Use the conditions shown to the under figure.

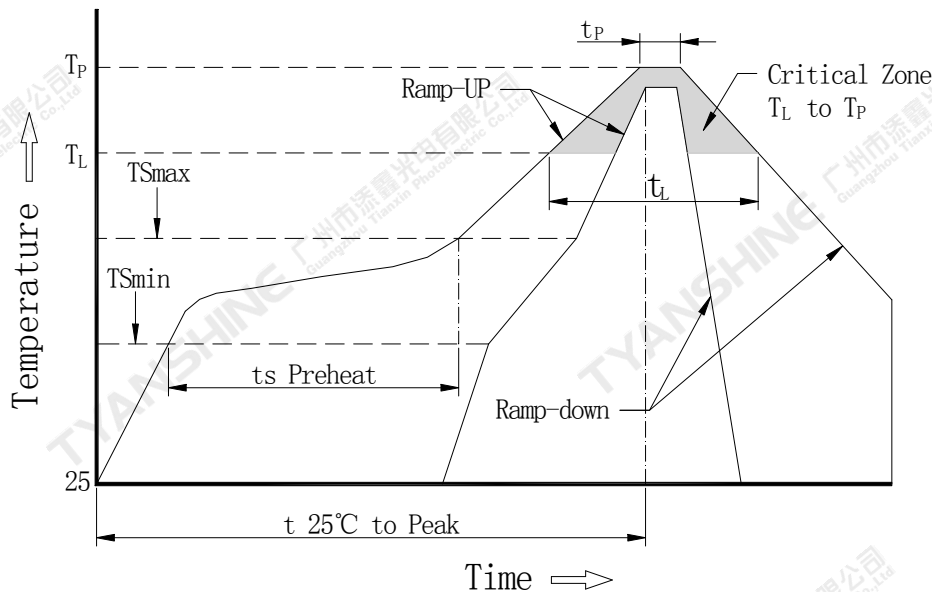

Profile Feature	Lead-Based Solder
Average Ramp-Up Rate (T_{Smax} to T_P)	3°C/second max.
Preheat: Temperature Min (T_{Smin})	100°C
Preheat: Temperature Max (T_{Smax})	150°C
Preheat: Time (T_{Smin} to T_{Smax})	60-120 seconds
Time Maintained Above: Temperature (T_L)	183°C
Time Maintained Above: Time (T_L)	60-150 seconds
Peak/Classification Temperature (T_P)	225°C
Time Within 5°C of Actual Peak Temperature (T_P)	10-30 seconds
Ramp-Down Rate	6°C/second max.
Time 25°C to Peak Temperature	6 minutes max.

Note:

All temperatures refer to topside of the package, measured on the package body surface.

Dimensions For Cannulation And Packaging

Quantity: 1000PCS

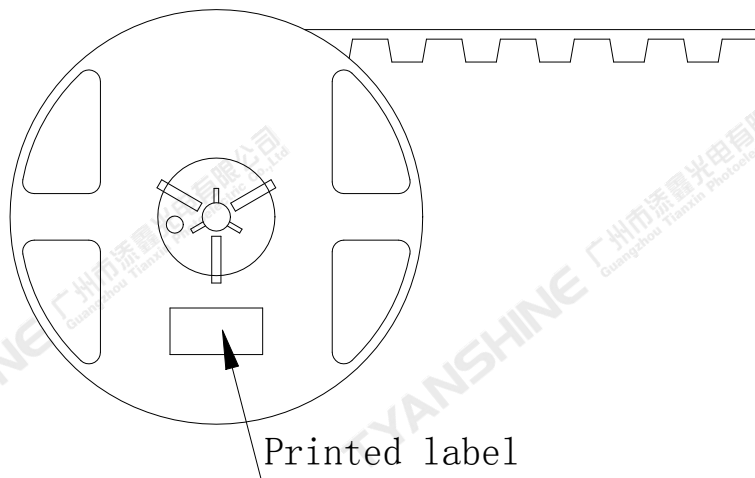
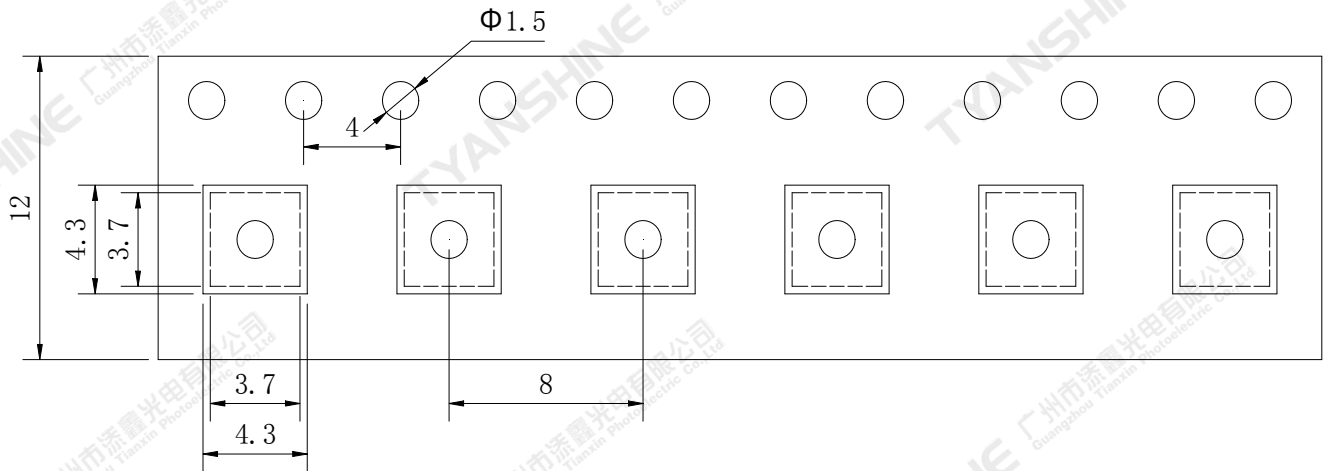

Notes:

1. All dimensions are in millimeters.
2. Tolerances are ± 2.0 mm unless otherwise noted.
3. The products are packaged together with silica gel, Transport, not to the weight of welding LED light-emitting area, As a result of the weight of LED light-emitting zone in the quality of, Irresponsible of the Company.

Part No.	TX-3535RGB4FC120-OGVCND34-02	Spec No.	WKF-BE0131	Page	9 of 9
----------	------------------------------	----------	------------	------	--------