

TX-4575W40FSA15-NU3CD-01

PRODUCT SPECIFICATION

Features:

- ◆Excellent transiting heat from LED chip operating under 1000mA.
- ◆Ceramic eutectic package allows it to have minimal internal stress and excellent thermal path.
- ◆Flip chip coated with package, the output of lumen is stable.
- ◆High luminous output.
- ◆Encapsulated materials are environmentally certified and meet environmental requirements.

Chip Material:

- ◆GaN

Emitting Color:

- ◆Cold white

Applications:

- ◆Automobile lighting

Part No.	TX-4575W40FSA15-NU3CD-01	Spec No.	WKF-EF0016	Page	1 of 9
----------	--------------------------	----------	------------	------	--------

Package Dimensions:

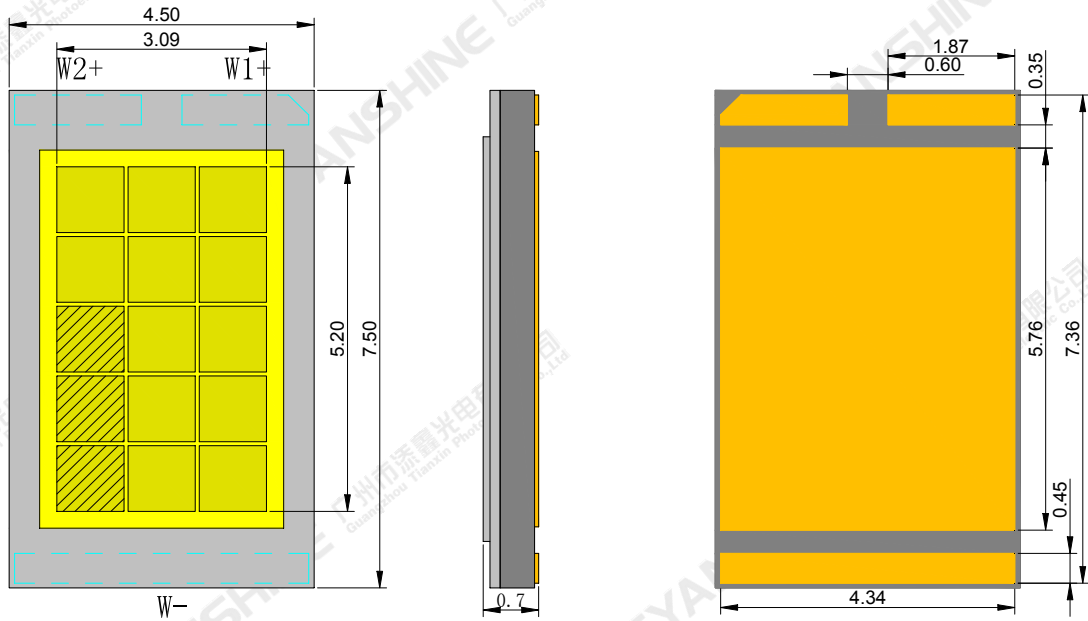

■ W1路15芯全亮，电压45V； ▨ W2路3芯亮，电压9V；

Top view

Side view

Bottom view

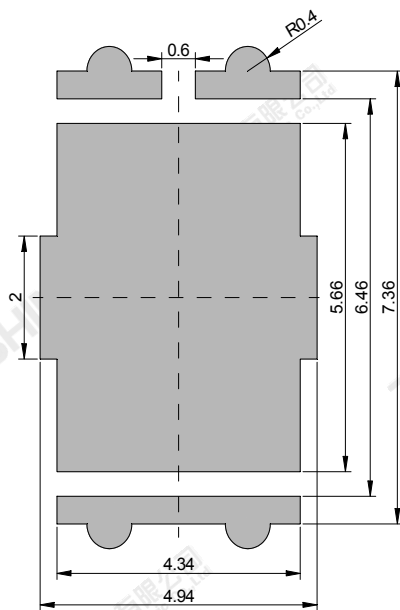

Recommended solder pad

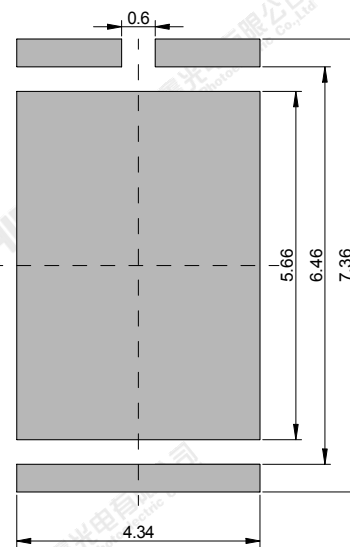

recommended stencil pattern

Notes:

- 1.All dimensions are in millimeters .
- 2.Tolerances unless otherwise mentioned are $\pm 0.1\text{mm}$.

Part No.	TX-4575W40FSA15-NU3CD-01	Spec No.	WKF-EF0016	Page	2 of 9
----------	--------------------------	----------	------------	------	--------

Absolute Maximum Ratings (Tc=25°C)

Parameter	Symbol	Ratings	Unit	
Forward Current	IF	W1	1000	mA
		W2	1000	
Reverse Voltage	VR	Not designed for reverse operation	V	
Power Dissipation	PD	45	W	
Junction Temperature	Tj	150	°C	
Electrostatic Discharge Threshold (ESD)	ESD	2000	V	
Storage Temperature	Tstg	-40~+70	°C	
Operation Temperature	Topr	-30~+125		

Notes:

- Specifications are subject to change without notice.
- The data on this specification is for reference only and the actual data is in accordance with the acknowledgment.
- Precautions for ESD:
STATIC SHIELD Electricity and surge damages the LED. It is recommended to use a wrist band or anti-electrostatic glove when handling the LED. All devices, equipment and machinery must be properly grounded.

Electrical Optical Characteristics (Tc=25°C)

Parameter	Symbol	Condition	Emitting color	Min.	Typ.	Max.	Units
Luminous Flux	ϕ_v	If=1000mA	W1	3600	3800	4000	lm
			W2	700	750	800	
Forward Voltage	V_f		W1	45	46	47	V
			W2	9.1	9.4	9.7	
Correlated Colour Temperature	CCT	If=200mA	W1	5700	6250	6700	K
Viewing Angle at 50% IV	$2\theta_{1/2}$	—	W1	—	120	—	Deg
			W2	—	120	—	
Reverse Current	I_R	—	W1	—	—	—	μA
			W2	—	—	—	
Thermal Resistance Junction to Case	$R\theta_{J-C}$	If=1000mA	—	—	0.69	—	K/W
Temperature Coefficient of Voltage	$V\Delta F/T$		—	—	-2.8	—	mV/°C

White light Color coordinate filing (IF=200mA)

Region	CCT Range		X1	Y1	X2	Y2	X3	Y3	X4	Y4
	Min	Max								
G10	5700K	6000K	0.3276	0.3497	0.3216	0.3390	0.3207	0.3518	0.3272	0.3627
F01	6000K	6500K	0.3216	0.3387	0.3134	0.3241	0.3117	0.3363	0.3207	0.3514
E11	6500K	6700K	0.3135	0.3233	0.3107	0.3184	0.3088	0.3302	0.3119	0.3354

Notes:

- Luminous intensity is measured with a light sensor and filter combination that approximates the CIE eye-response curve.
- $\theta_{1/2}$ is the off-axis angle at which the luminous intensity is half the axial luminous intensity.
- The dominant wavelength (λ_d) is derived from the CIE chromaticity diagram and represents the single wavelength which defines the color of the device.
- Luminous flux measurement tolerance:±15%.
- Forward voltage measurement tolerance:±0.15V.

Part No.	TX-4575W40FSA15-NU3CD-01	Spec No.	WKF-EF0016	Page	4 of 9
----------	--------------------------	----------	------------	------	--------

Typical Electrical/Optical Characteristics Curves

(25°C Ambient Temperature Unless Otherwise Noted)

Forward Current VS. Forward Voltage

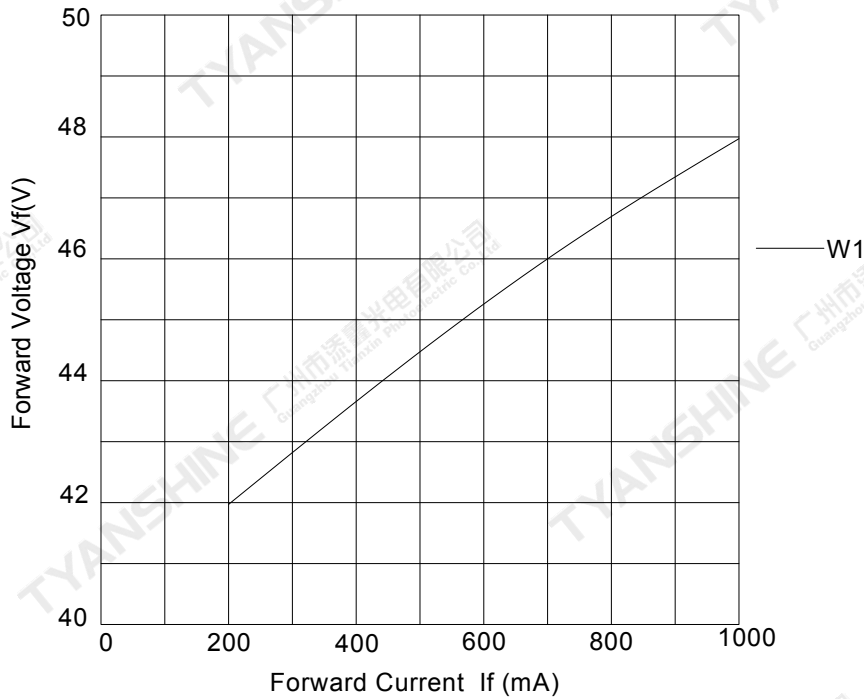

Forward Current VS. Luminous flux

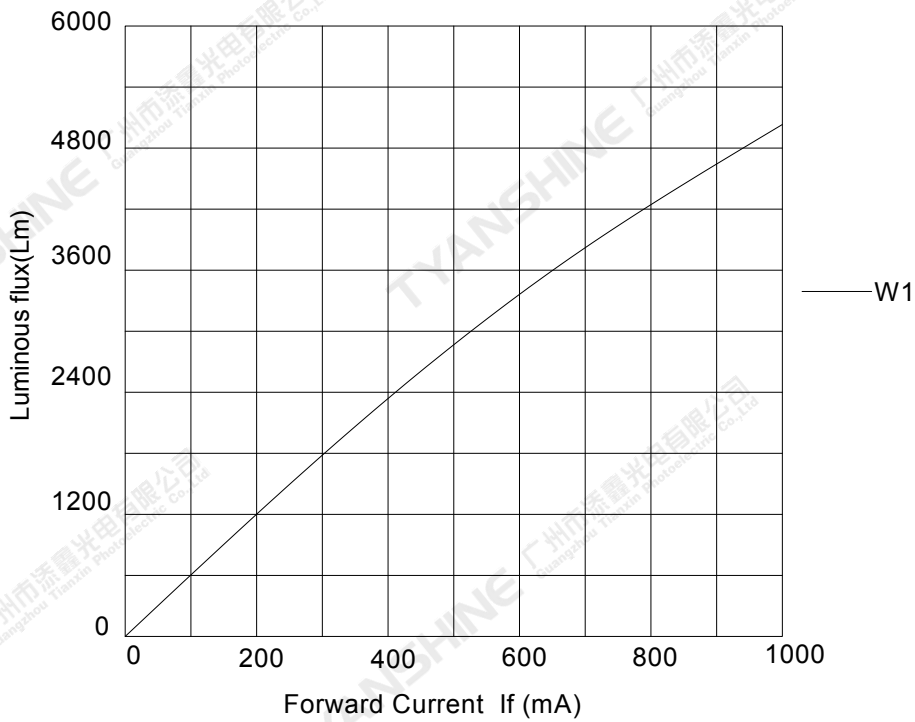

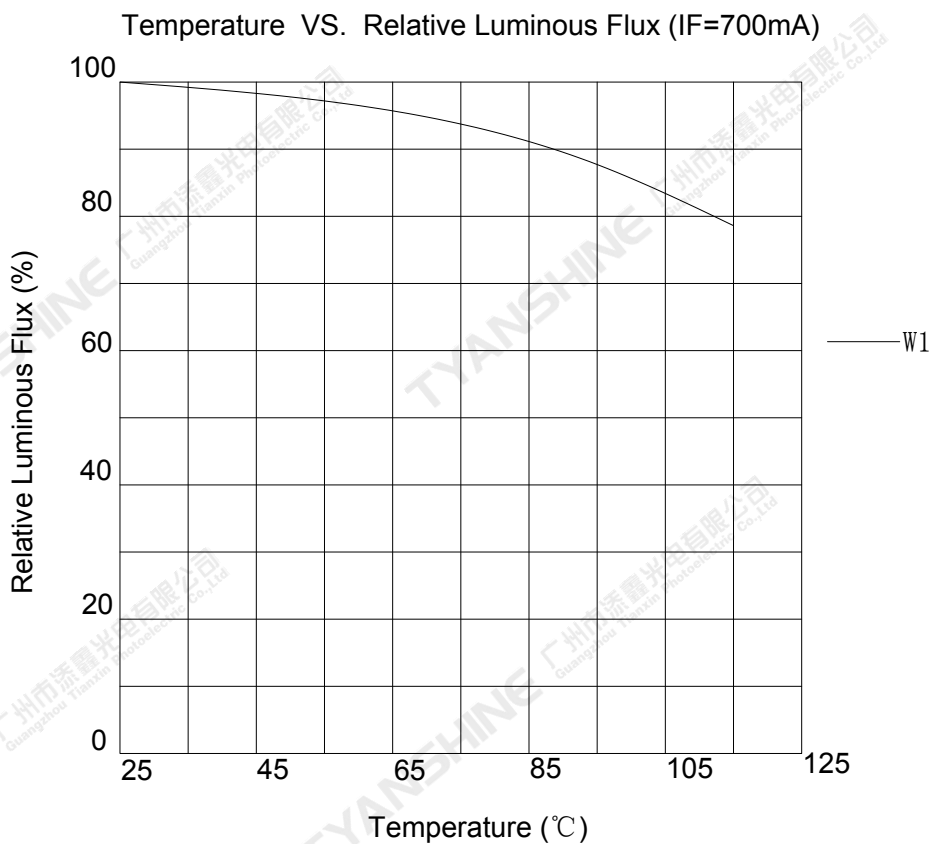
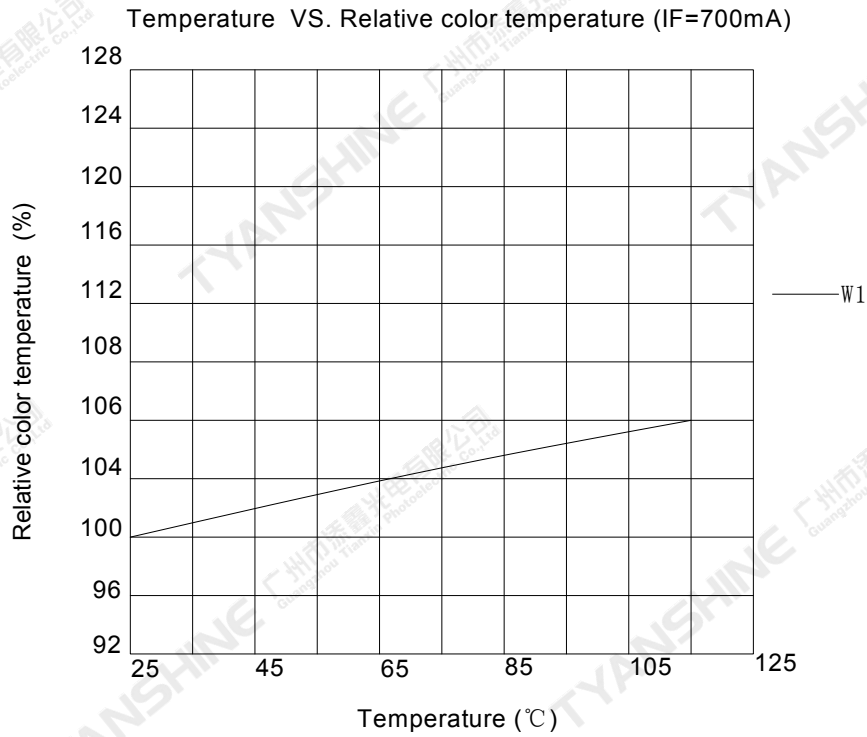

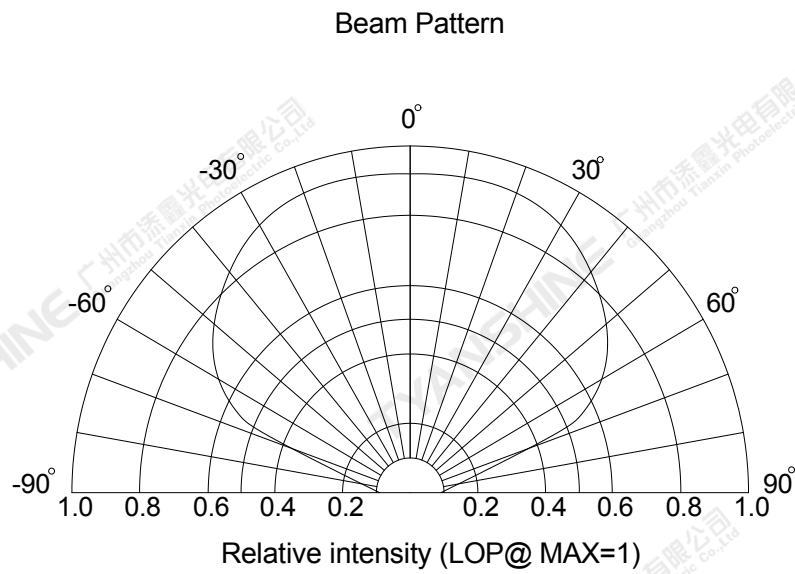
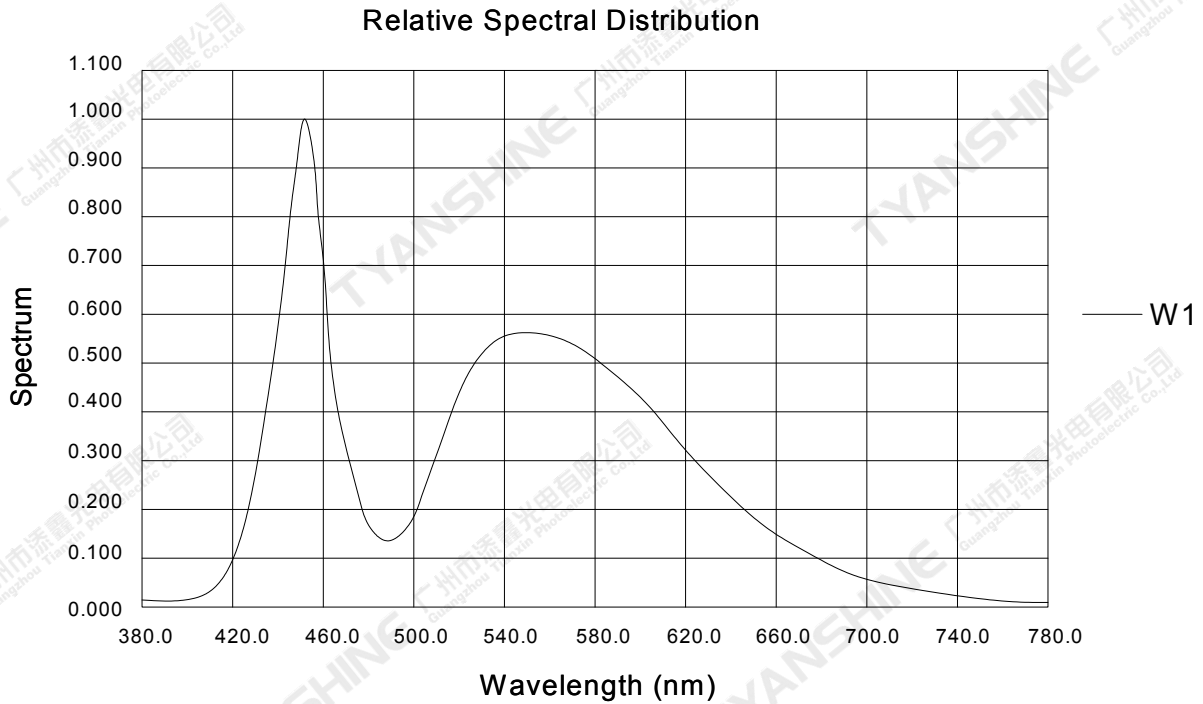

Notes:

1. $2\theta_{1/2}$ is the off axis angle from lamp centerline where the luminous intensity is 1/2 of the peak value.
2. View angle tolerance is $\pm 5^\circ$.

Part No.	TX-4575W40FSA15-NU3CD-01	Spec No.	WKF-EF0016	Page	7 of 9
----------	--------------------------	----------	------------	------	--------

Usage Precautions

Storage Environment Condition

Temperature: 5°C ~ 30°C (41°F ~ 86°F)

Humidity: 60% RH Max.

Soldering Condition

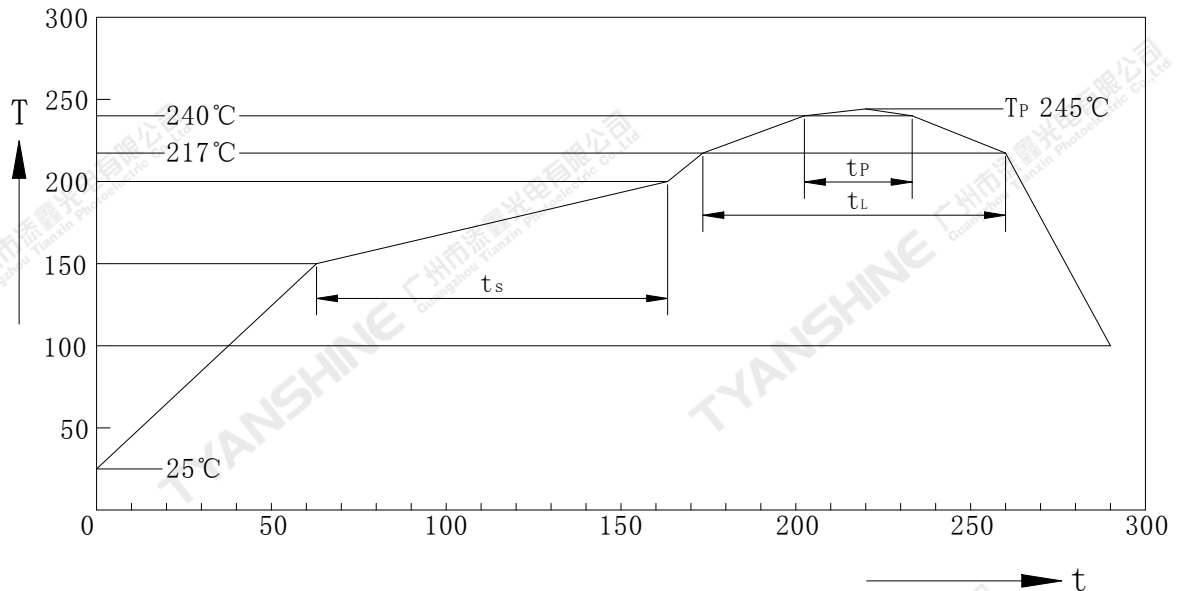

Profil-Charakteristik Profile Feature	Symbol	Pb-Free(SnAgCu)Assembly			Einheit Unit
		Minimum	Recommendation	Maximum	
Ramp-up Rate to Preheat 25°C to 150°C	-	-	2	3	K/s
Time t_s T_{Smin} to T_{Smax}	t_s	60	100	120	s
Ramp-up Rate to Peak T_{Smax} to T_p	-	-	2	3	K/s
Liquidus Temperature	T_L	217			°C
Time above Liquidus temperature	t_L	-	80	100	s
Peak Temperature	T_P	-	245	260	°C
Time within 5°C of the specified peak temperature T_p-5 K	t_p	10	20	30	s
Ramp-down Rate T_p to 100°C	-	-	3	6	K/s
Time 25°C to T_p	-	-	-	480	-

Note:

All temperatures refer to topside of the package, measured on the package body surface.

Dimensions For Cannulation And Packaging

Quantity: 1000PCS

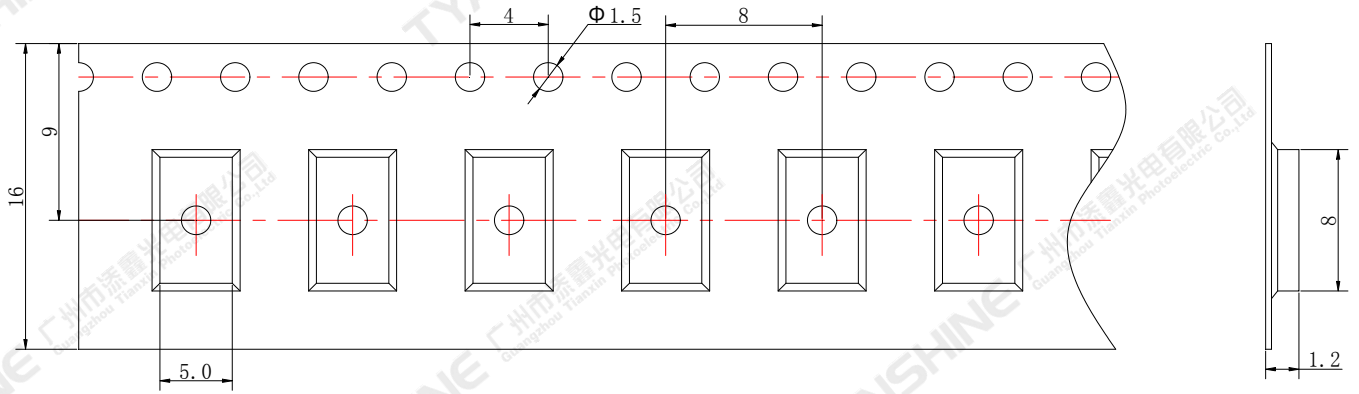

Notes:

1. All dimensions are in millimeters.
2. Tolerances are ± 2.0 mm unless otherwise noted.
3. The products are packaged together with silica gel, Transport, not to the weight of welding LED light-emitting area, As a result of the weight of LED light-emitting zone in the quality of, Irresponsible of the Company.

Part No.	TX-4575W40FSA15-NU3CD-01	Spec No.	WKF-EF0016	Page	9 of 9
----------	--------------------------	----------	------------	------	--------