

TX-6065RGBW60FC120-NUVENG-01R

PRODUCT SPECIFICATION

Features:

- ◆ Provide uniform cross distribution of positive white and warm white dual color scheme, mixed pure.
- ◆ High luminous output.
- ◆ No UV.
- ◆ Encapsulated materials are environmentally certified and meet environmental requirements.

Chip Material:

- ◆ Red: AlGaInP
- ◆ Green: GaInN
- ◆ Blue: GaN
- ◆ White: GaN

Emitting Color:

- ◆ Red (R)
- ◆ Green (G)
- ◆ Blue (B)
- ◆ White (W)

Applications:

- ◆ Entertainment lighting
- ◆ Landscape lighting
- ◆ Commercial lighting
- ◆ Decorative lighting

Part No.	TX-6065RGBW60FC120-NUVENG-01R	Spec No.	WKF-FC0184	Page	1 of 10
----------	-------------------------------	----------	------------	------	---------

Package Dimensions:

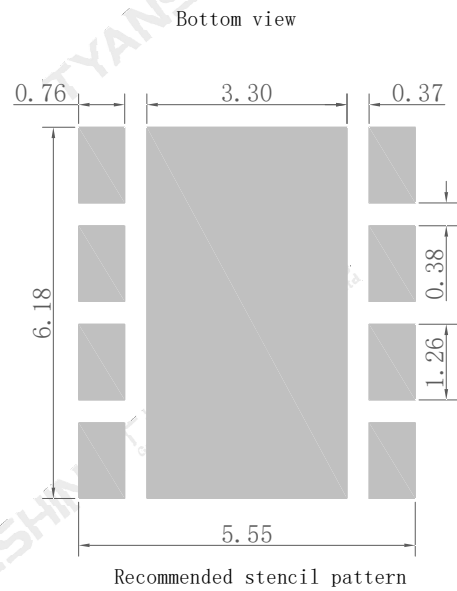
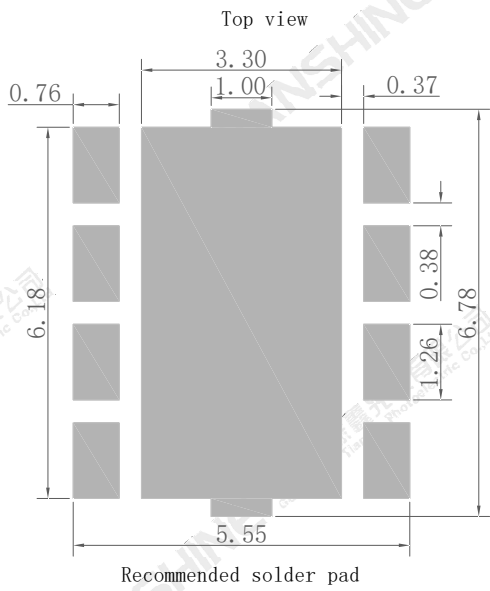
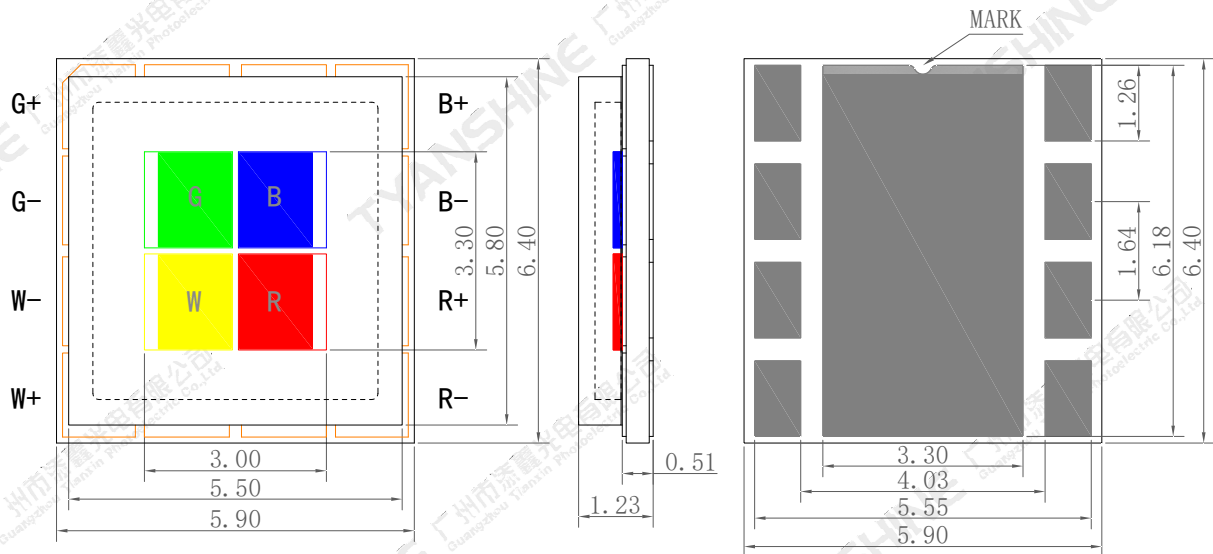

Notes:

- 1.All dimensions are in millimeters .
- 2.Tolerances unless otherwise mentioned are $\pm 0.1\text{mm}$.

Part No.	TX-6065RGBW60FC120-NUVENG-01R	Spec No.	WKF-FC0184	Page	2 of 10
----------	-------------------------------	----------	------------	------	---------

Absolute Maximum Ratings (Tc=25°C)

Parameter	Symbol	Ratings	Unit
Forward Current	R	5.0	A
	G	5.0	
	B	5.0	
	W	5.0	
Reverse Voltage	V _R	Not designed for reverse operation	V
Power Dissipation	R	13.5	W
	G	18	
	B	18	
	W	18	
Junction Temperature	R	125	°C
	G	150	
	B	150	
	W	150	
Electrostatic Discharge Threshold (ESD)	ESD	2000	V
Storage Temperature(Only for LED, not including packaging)	T _{stg}	-40~+85	°C
Operation Temperature	T _{opr}	-40~+85	

Notes:

- Specifications are subject to change without notice.
- The data on this specification is for reference only and the actual data is in accordance with the acknowledgment.
- Precautions for ESD:
STATIC SHIELD Electricity and surge damages the LED. It is recommended to use a wrist band or anti-electrostatic glove when handling the LED. All devices, equipment and machinery must be properly grounded.

Electrical Optical Characteristics (Tc=25°C)

Parameter	Symbol	Condition	Emitting Color	Min.	Typ.	Max.	Units
Luminous Flux	ϕ_v	If=1.0A	R	110	130	145	lm
			G	285	335	375	
			B	40	45	52	
			W	350	415	460	
Forward Voltage	V_f	If=1.0A	R	2.0	2.4	2.7	V
			G	2.9	3.3	3.6	
			B	2.9	3.3	3.6	
			W	2.9	3.3	3.6	
Dominant Wavelength	λ_d	If=1.0A	R	618	623	628	nm
			G	528	533	538	
			B	448	453	458	
Peak-emission Wavelength	λ_p	If=1.0A	R	627	632	637	nm
			G	520	525	530	
			B	443	448	453	
Spectral Line Half-Width	$\Delta\lambda$	If=1.0A	R	11	16	21	nm
			G	25	30	35	
			B	12	17	22	
			W	12	17	22	
Correlated Colour Temperature	CCT	If=1.0A	W	5700	—	6750	K
Reverse Current	I_R	—	—	—	—	2	μA
Viewing Angle at 50 % IV	$2\theta_{1/2}$	—	—	—	120	—	Deg
Thermal Resistance Junction to Case	$R\theta_{J-C}$	—	—	—	0.6	—	K/W
Temperature Coefficient of Voltage	$V\Delta F/T$	If=1.0A	R	—	-1.85	—	mV/°C
			G	—	-1.85	—	
			B	—	-1.85	—	
			W	—	-1.85	—	

Notes:

- Luminous intensity is measured with a light sensor and filter combination that approximates the CIE eye-response curve.
- $\theta_{1/2}$ is the off-axis angle at which the luminous intensity is half the axial luminous intensity.
- Luminous flux measurement tolerance:±15%.
- Forward voltage measurement tolerance:±0.15V.

Part No.	TX-6065RGBW60FC120-NUVENG-01R	Spec No.	WKF-FC0184	Page	4 of 10
----------	-------------------------------	----------	------------	------	---------

White Color coordinate filing (IF=1.0A Tc=25°C)

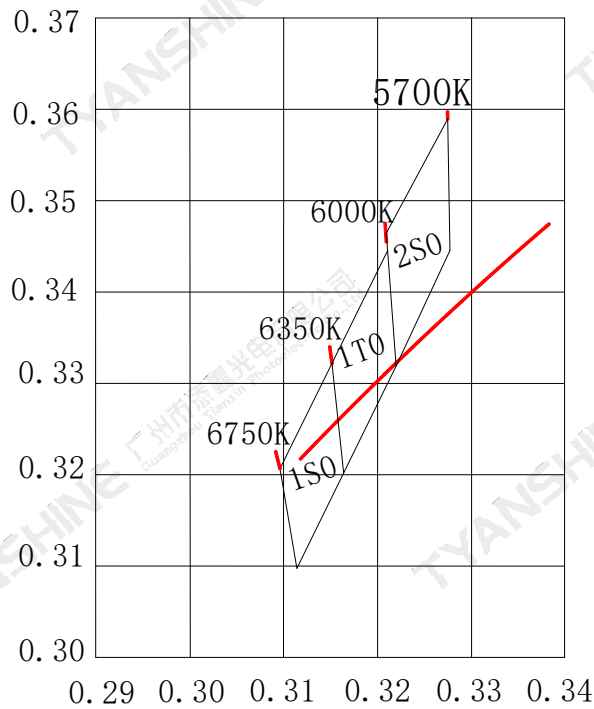

Region	CCT Range		X1	Y1	X2	Y2	X3	Y3	X4	Y4
	Min	Max								
2S0	5700K	6000K	0.3277	0.3446	0.3275	0.3589	0.3209	0.3464	0.3220	0.3319
1T0	6000K	6350K	0.3220	0.3319	0.3211	0.3445	0.3151	0.3322	0.3164	0.3202
1S0	6350K	6750K	0.3164	0.3202	0.3151	0.3322	0.3096	0.3207	0.3114	0.3098

Typical Electrical/Optical Characteristics Curves

(25°C Ambient Temperature Unless Otherwise Noted)

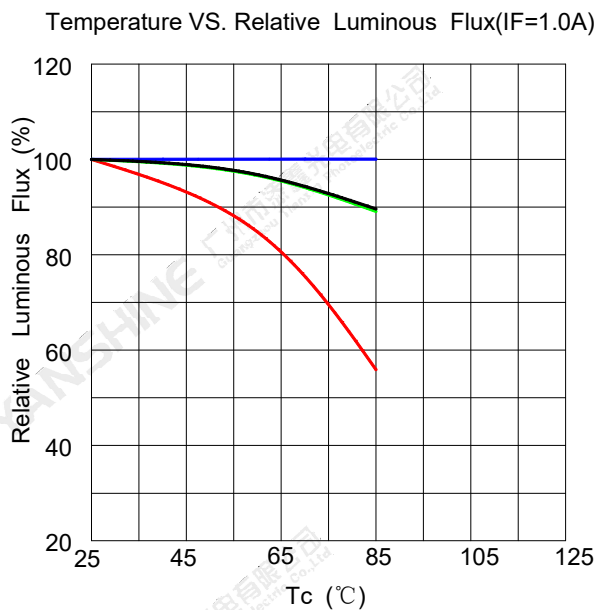
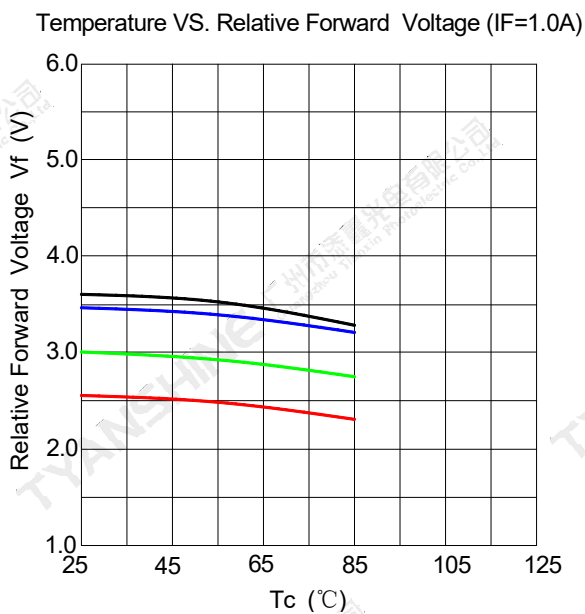
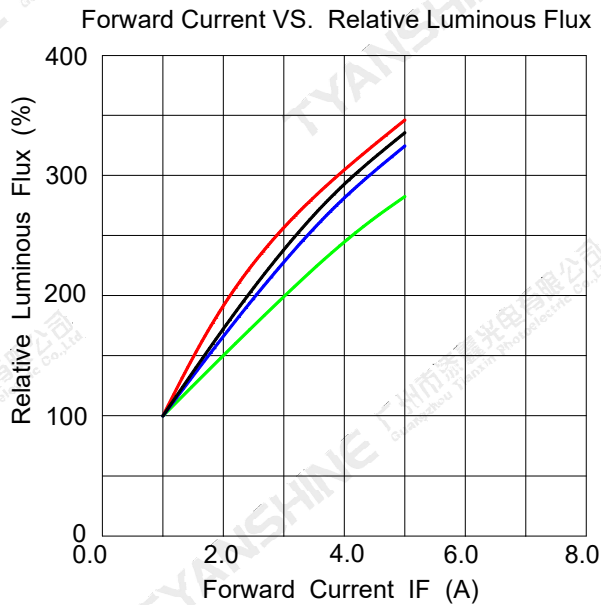
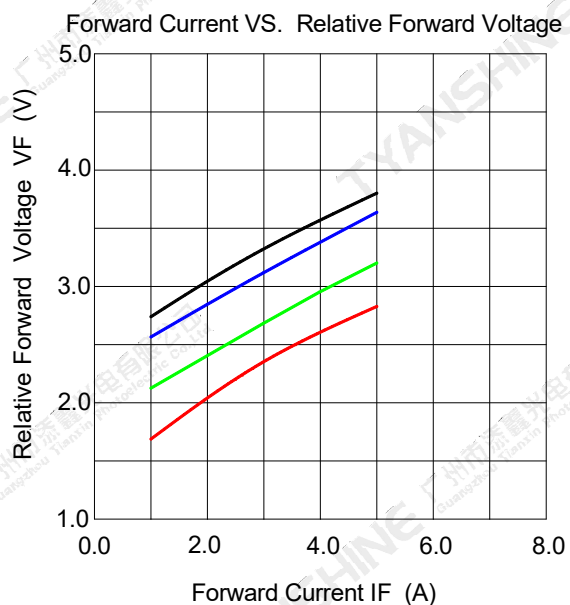

Notes: — Red; — Green; — Blue; — White;

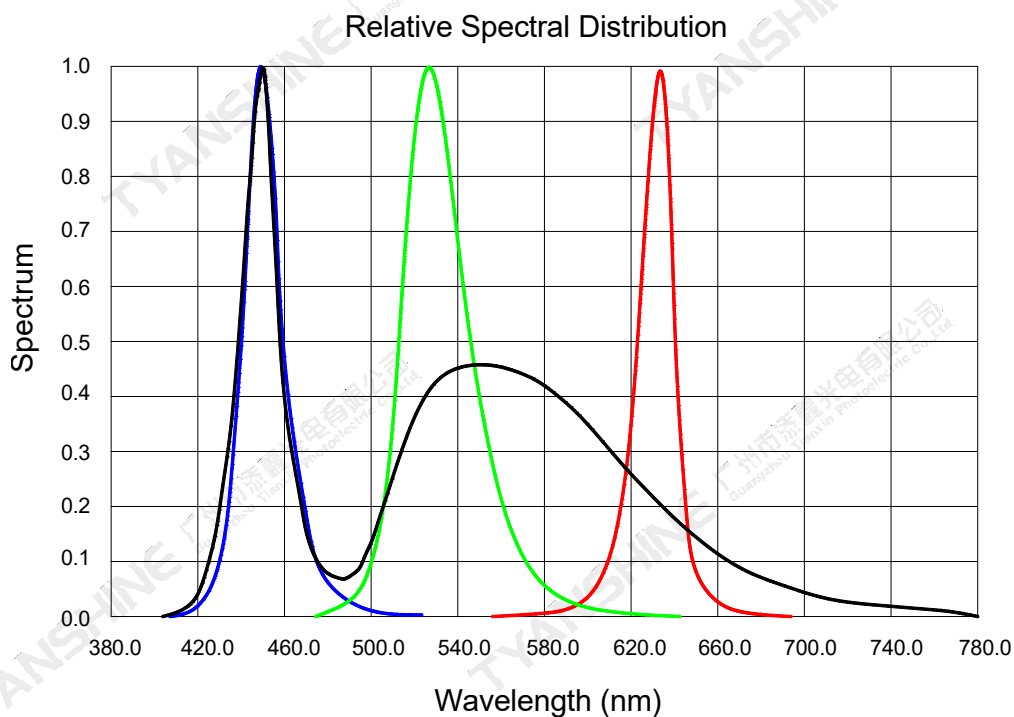
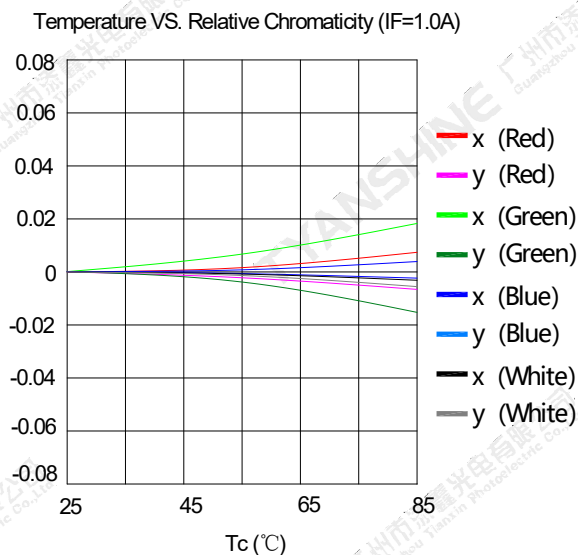
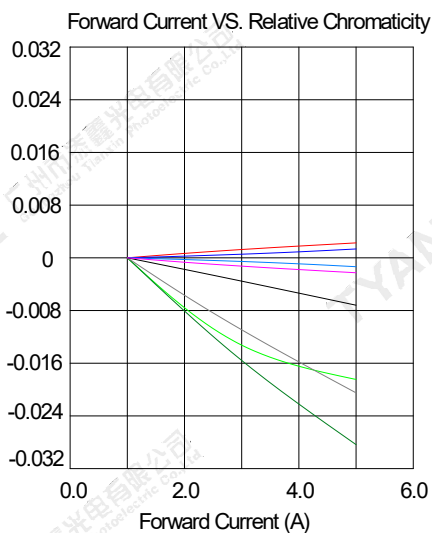

Notes: — Red; — Green; — Blue; — White;

Notes:

1. $2\theta_{1/2}$ is the off axis angle from lamp centerline where the luminous intensity is 1/2 of the peak value.
2. View angle tolerance is $\pm 5^\circ$.

Usage Precautions

Storage Environment Condition

Temperature: 5°C ~ 30°C (41°F ~ 86°F)

Humidity: 60% RH Max.

Soldering Condition

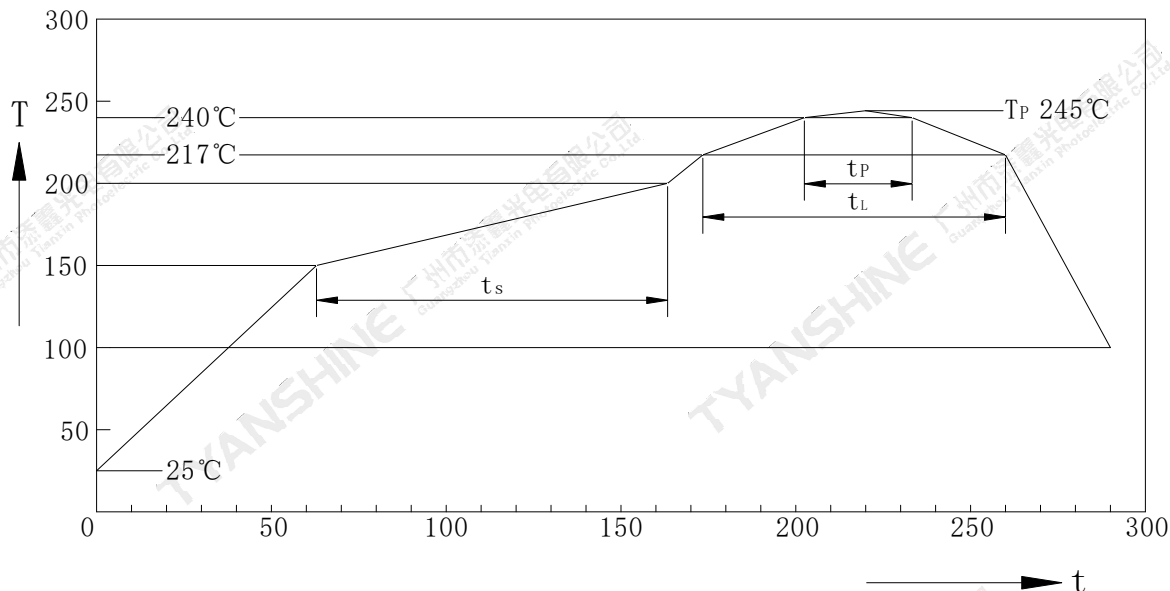

Profil-Charakteristik Profile Feature	Symbol	Pb-Free(SnAgCu)Assembly			Einheit Unit
		Minimum	Recommendation	Maximum	
Ramp-up Rate to Preheat 25°C to 150°C	-	-	2	3	K/s
Time t_s T_{Smin} to T_{Smax}	t_s	60	100	120	s
Ramp-up Rate to Peak T_{Smax} to T_p	-	-	2	3	K/s
Liquidus Temperature	T_L	217			°C
Time above Liquidus temperature	t_L	-	80	100	s
Peak Temperature	T_P	-	245	255	°C
Time within 5°C of the specified peak temperature T_p-5 K	t_p	10	20	30	s
Ramp-down Rate T_p to 100°C	-	-	3	6	K/s
Time 25°C to T_p	-	-	-	480	-

Note:

All temperatures refer to topside of the package, measured on the package body surface.

Dimensions For Cannulation And Packaging

Quantity:1000PCS

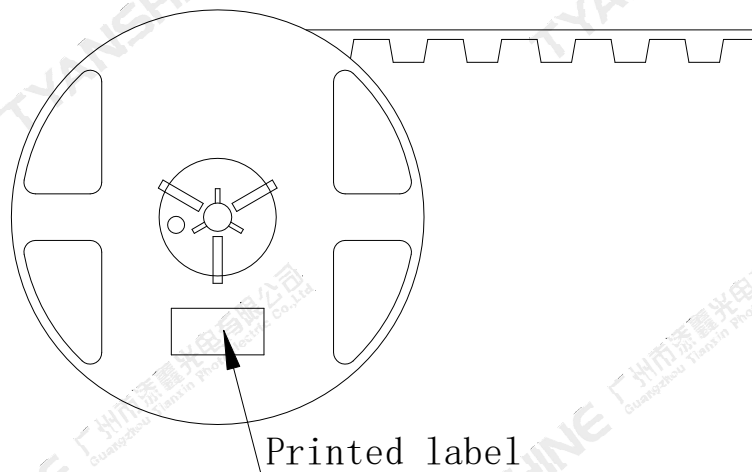
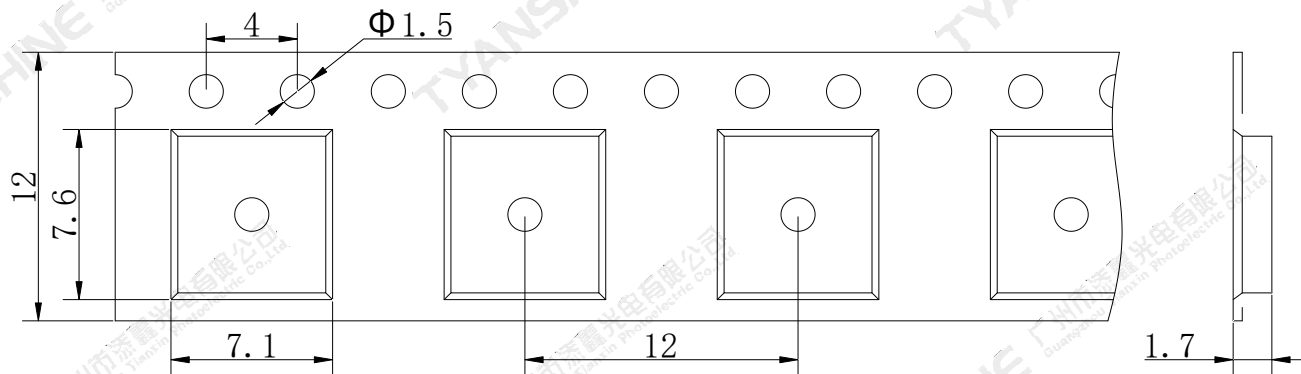

Notes:

1. All dimensions are in millimeters.
2. Tolerances are ± 2.0 mm unless otherwise noted.
3. The products are packaged together with silica gel, Transport, not to the weight of welding LED light-emitting area, As a result of the weight of LED light-emitting zone in the quality of, Irresponsible of the Company.

Part No.	TX-6065RGBW60FC120-NUVENG-01R	Spec No.	WKF-FC0184	Page	9 of 10
----------	-------------------------------	----------	------------	------	---------

