

TX-3535RGBW10VSD1-NG4DC-01H80

PRODUCT SPECIFICATION

Features:

- ◆ Excellent transiting heat from LED chip operating under R:1000mA GBW:1200mA
- ◆ High luminous output
- ◆ No UV

Moisture Proof Grade:

- ◆ LEVEL1

Emitting Color:

- ◆ Red (R)
- ◆ Green (G)
- ◆ Blue (B)
- ◆ White (W)

Applications:

- ◆ Portable flashlight
- ◆ Garden lighting
- ◆ General lighting

Package Dimensions:

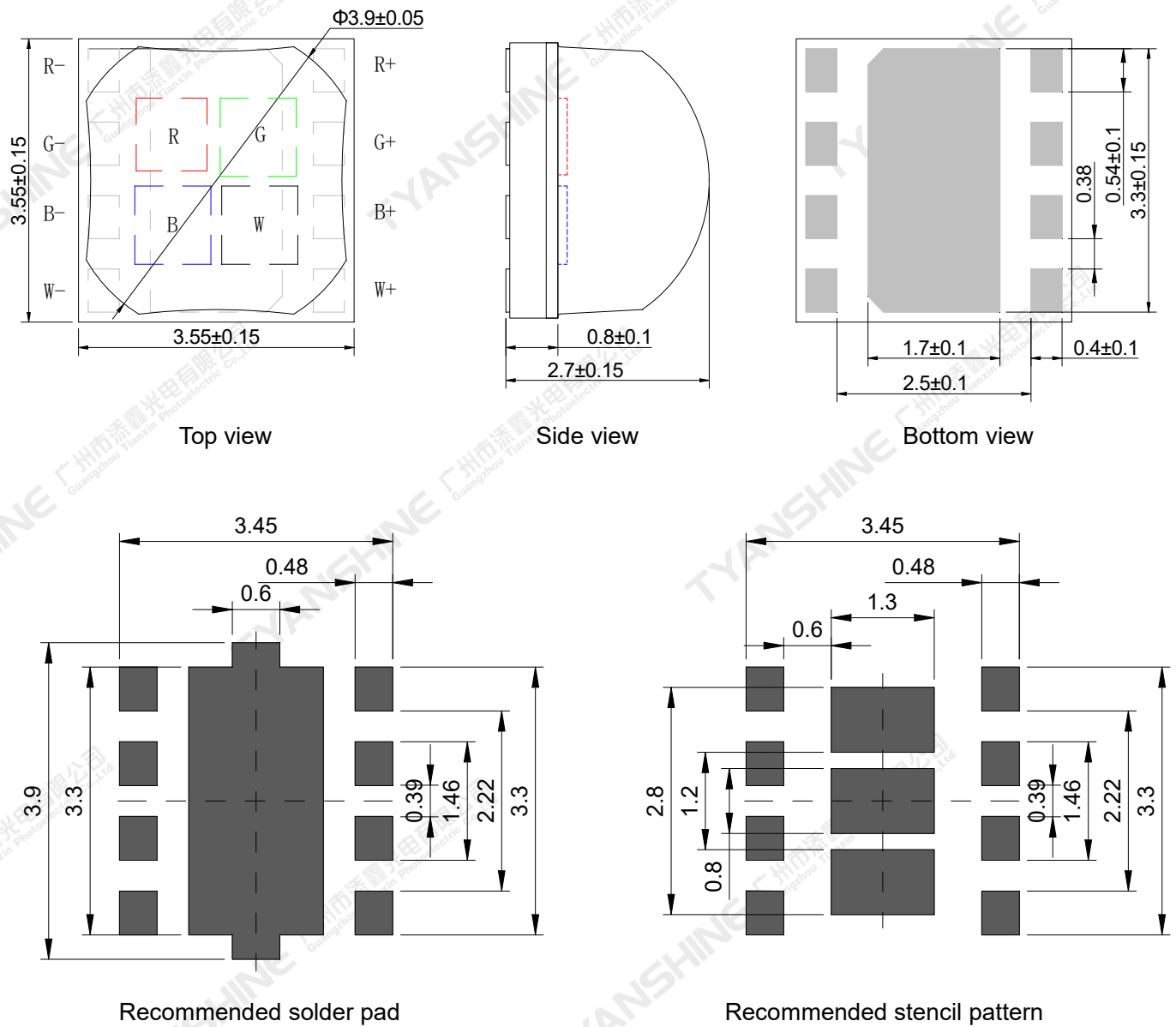

Notes:

1. All dimensions are in millimeters .
2. Tolerances unless otherwise mentioned are ± 0.15 mm .

Absolute Maximum Ratings (Tc=25°C)

Parameter	Symbol	Max Ratings	Unit	
Forward Current	IF	R	1000	mA
		G	1200	
		B	1200	
		W	1200	
Peak Forward Current (Condition 1)	IFP	R	1200	
		G	1800	
		B	1800	
		W	1800	
Reverse Voltage	VR	7	V	
Power Dissipation	PD	R	2400	mW
		G	3840	
		B	3720	
		W	3840	
Junction Temperature	Tj	R	125	°C
		G	150	
		B	150	
		W	150	
Electrostatic Discharge Threshold (ESD)	ESD	2000	V	
Storage Temperature	Tstg	-40~70	°C	
Operation Temperature	Topr	-30~85		
Ceramic side temperature(Notes 4)	Tcs	85		

Condition 1.Pulse width ≤0.1 msec, duty ≤1/10.

Notes:

- Specifications are subject to change without notice.
- The data on this specification is for reference only and the actual data is in accordance with the acknowledgment.
- Precautions for ESD:
STATIC SHIELD Electricity and surge damages the LED. It is recommended to use a wrist band or anti-electrostatic glove when handling the LED. All devices, equipment and machinery must be properly grounded.
- Temperature on the side of the ceramic substrate near the heat sink.

Part No.	TX-3535RGBW10VSD1-NG4DC-01H80	Spec No.	WKF-ED0151	Page	3 of 10
----------	-------------------------------	----------	------------	------	---------

Electrical Optical Characteristics (Tc=25°C, IF=700mA)

Parameter	Symbol	Emitting Color	Min.	Typ.	Max.	Units
Luminous Flux	ϕ_v	R	110	122	135	lm
		G	200	217	235	
		B	55	60	65	
		W	210	227	245	
Correlated Colour Temperature	CCT	W1	3780	4050	4350	K
		W2	4800	5150	5550	
Color Rendering Index	Ra	W	80	82	—	—
Dominant Wavelength	λ_d	R	616	621	626	nm
		G	521	526	531	
		B	465	468	470	
Peak-emission Wavelength	λ_p	R	625	630	635	nm
		G	515	520	525	
		B	460	463	465	
Spectral Line Half-Width	$\Delta\lambda$	R	14	16	18	nm
		G	30	35	40	
		B	18	21	24	
		W	130	145	160	
Forward Voltage	V_f	R	2.0	2.4	2.7	V
		G	2.9	3.2	3.6	
		B	2.8	3.1	3.5	
		W	2.9	3.2	3.6	
Reverse Current	I_R	$V_R=7V$	—	—	5	μA
Viewing Angle at 50% IV	$2\theta_{1/2}$	—	—	120	—	Deg
Thermal Resistance Junction to Case	$R\theta_{J-C}$	R	—	5.3	—	K/W
		G	—	5.3	—	
		B	—	5.3	—	
		W	—	5.3	—	
Temperature Coefficient of Voltage	$V\Delta F/T$	R	—	-5.4	—	mV/°C
		G	—	-2.1	—	
		B	—	-2.0	—	
		W	—	-5.4	—	

White light Color coordinate filing (IF=700mA)

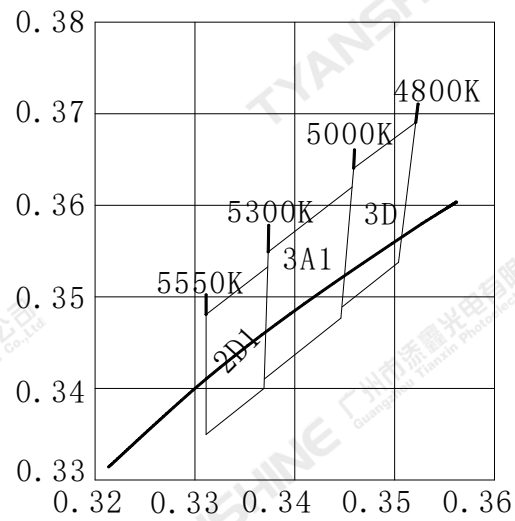
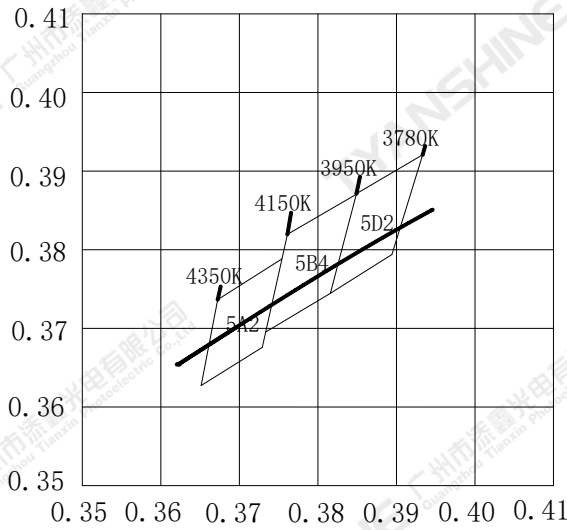

Region	CCT Range		X1	Y1	X2	Y2	X3	Y3	X4	Y4
	Min	Max								
5D2	3780K	3950K	0.3816	0.3745	0.3849	0.3871	0.3933	0.3921	0.3894	0.3794
5B4	3950K	4150K	0.3733	0.3695	0.3761	0.382	0.3849	0.387	0.3816	0.3745
5A2	4150K	4350K	0.3651	0.3627	0.3672	0.3737	0.3754	0.3788	0.3729	0.3676
3D	4800K	5000K	0.3448	0.3489	0.3459	0.3640	0.3521	0.3690	0.3504	0.3538
3A1	5000K	5300K	0.3369	0.3410	0.3373	0.3549	0.3457	0.3620	0.3446	0.3477
2D1	5300K	5550K	0.3311	0.3350	0.3311	0.3481	0.3373	0.3533	0.3369	0.3400

Notes:

- 1.Luminous intensity is measured with a light sensor and filter combination that approximates the CIE eye-response curve.
2. $\theta_{1/2}$ is the off-axis angle at which the luminous intensity is half the axial luminous intensity.
- 3.Luminous flux measurement tolerance: $\pm 10\%$.
- 4.Forward voltage measurement tolerance: $\pm 10\%V$.
- 5.Ra measurement tolerance: ± 2 .

Typical Electrical/Optical Characteristics Curves

(25°C Ambient Temperature Unless Otherwise Noted)

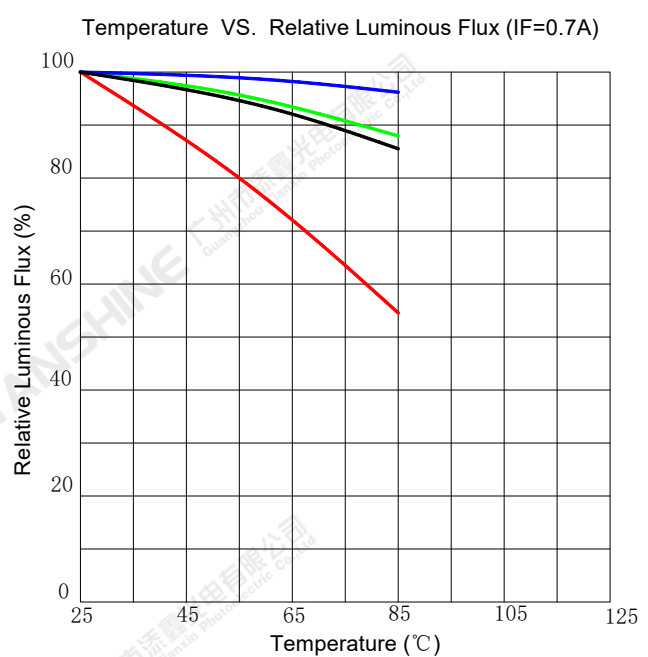
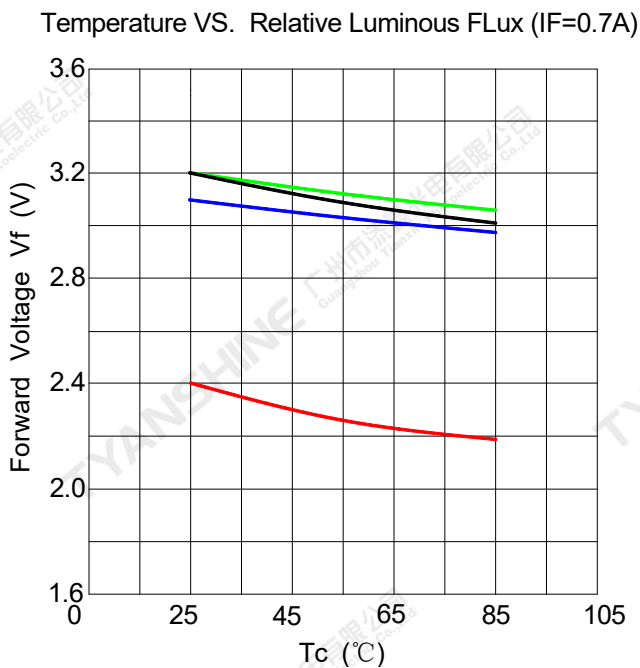
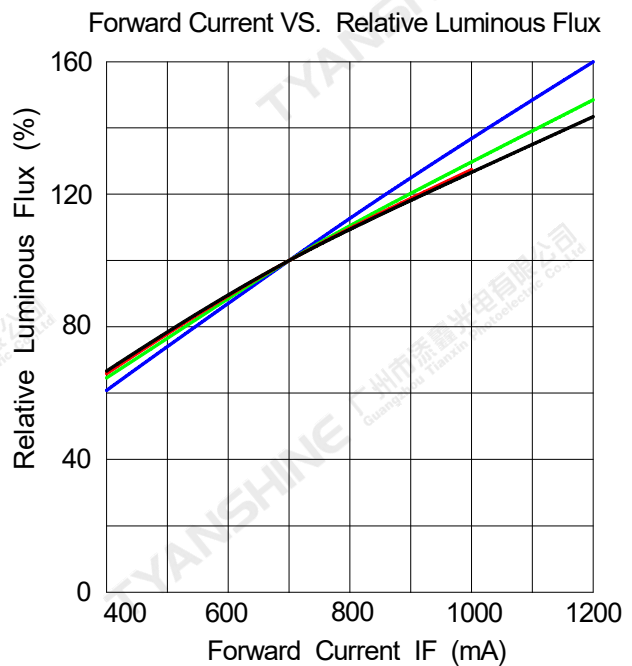
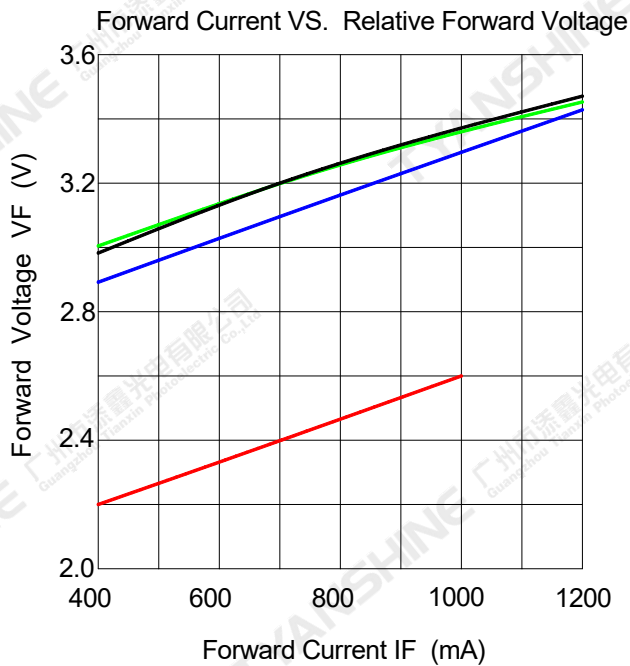

Notes: — Red (R) ; — Green (G) ; — Blue (B) ; — White (W) ;

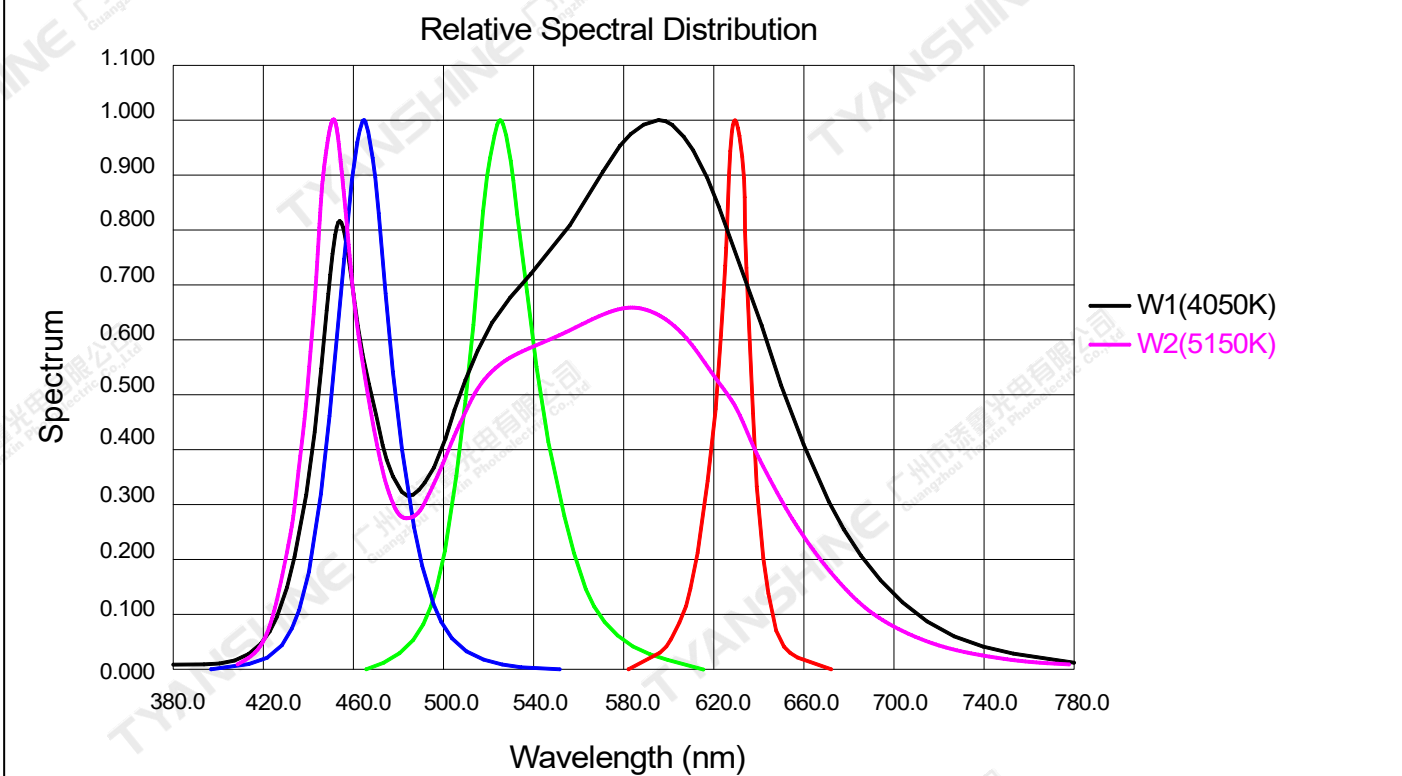
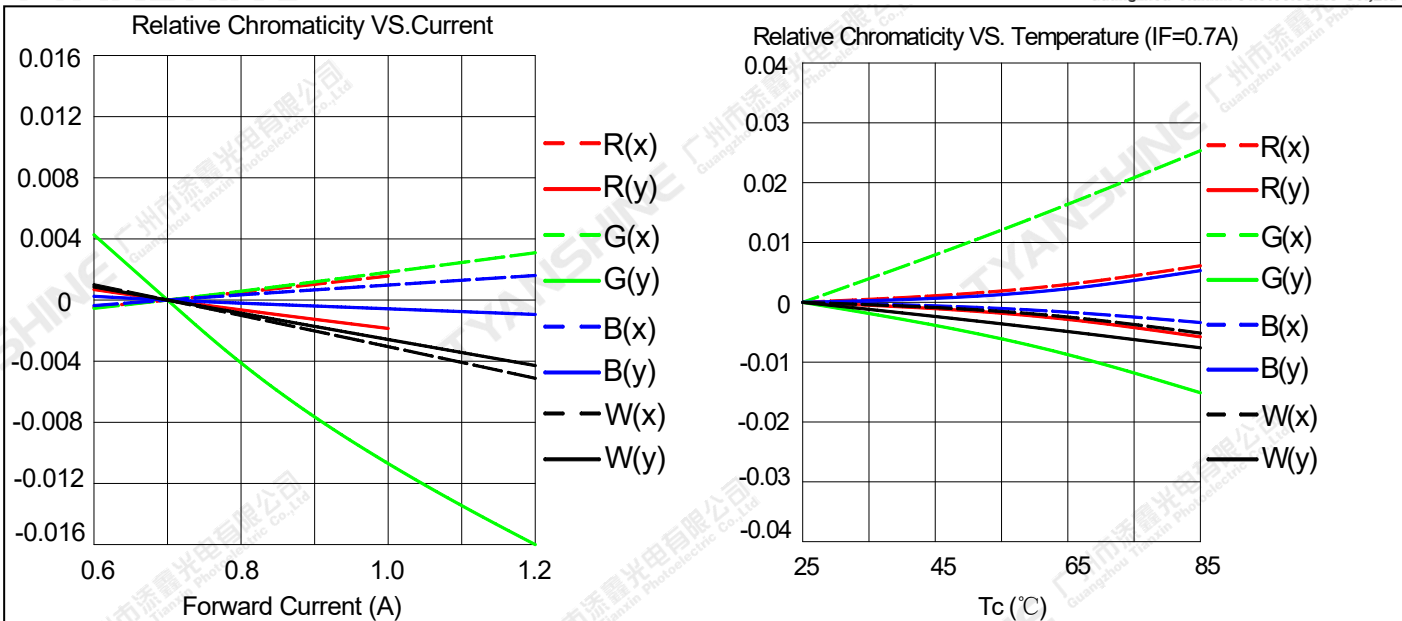

Notes: ■ Red (R) ; ■ Green (G) ; ■ Blue (B) ; ■ White (W) ;

Notes:

1. $2\theta_{1/2}$ is the off axis angle from lamp centerline where the luminous intensity is 1/2 of the peak value.
2. View angle tolerance is $\pm 5^\circ$.

Usage Precautions

Storage Environment Condition

Temperature: 5°C ~ 30°C (41°F ~ 86°F)

Humidity: 60% RH Max.

Soldering Condition

Use the conditions shown to the under figure.

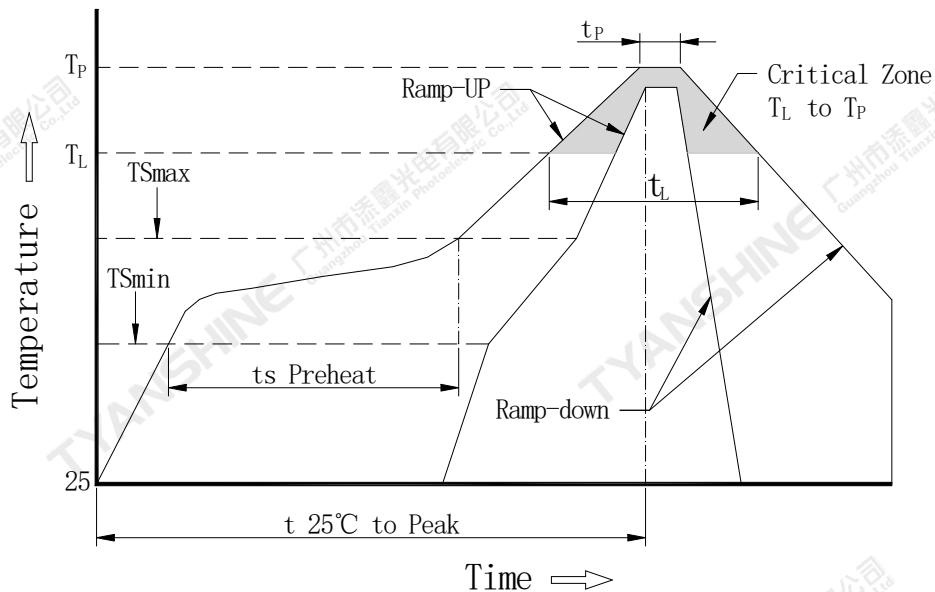

Profile Feature	Pb-Free Solderr(SnBi35Ag0.3)
Average Ramp-Up Rate (T _{Smax} to T _P)	3°C/second max.
Preheat: Temperature Min (T _{Smin})	130°C
Preheat: Temperature Max (T _{Smax})	190°C
Preheat: Time (T _{Smin} to T _{Smax})	120-180 seconds
Time Maintained Above: Temperature (T _L)	230°C
Time Maintained Above: Time (T _L)	60-150 seconds
Peak/Classification Temperature (T _P)	255°C
Time Within 5°C of Actual Peak Temperature (T _P)	10-35seconds
Ramp-Down Rate	5°C/second max.
Time 25°C to Peak Temperature	7 minutes max.

Note:

All temperatures refer to topside of the package, measured on the package body surface.

Dimensions For Cannulation And Packaging

Quantity: 700PCS

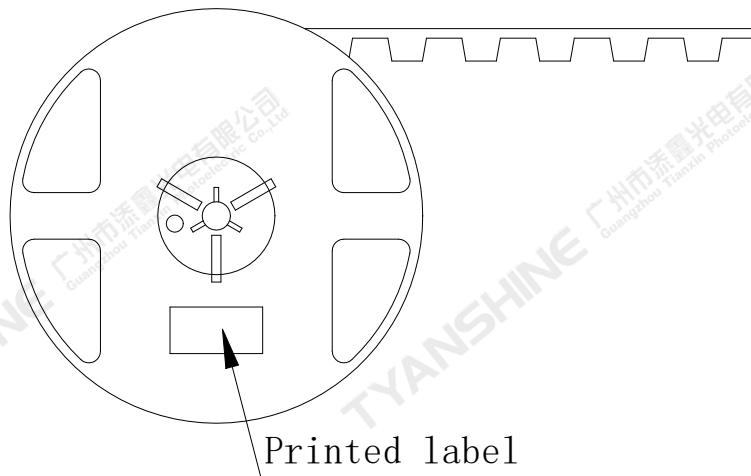
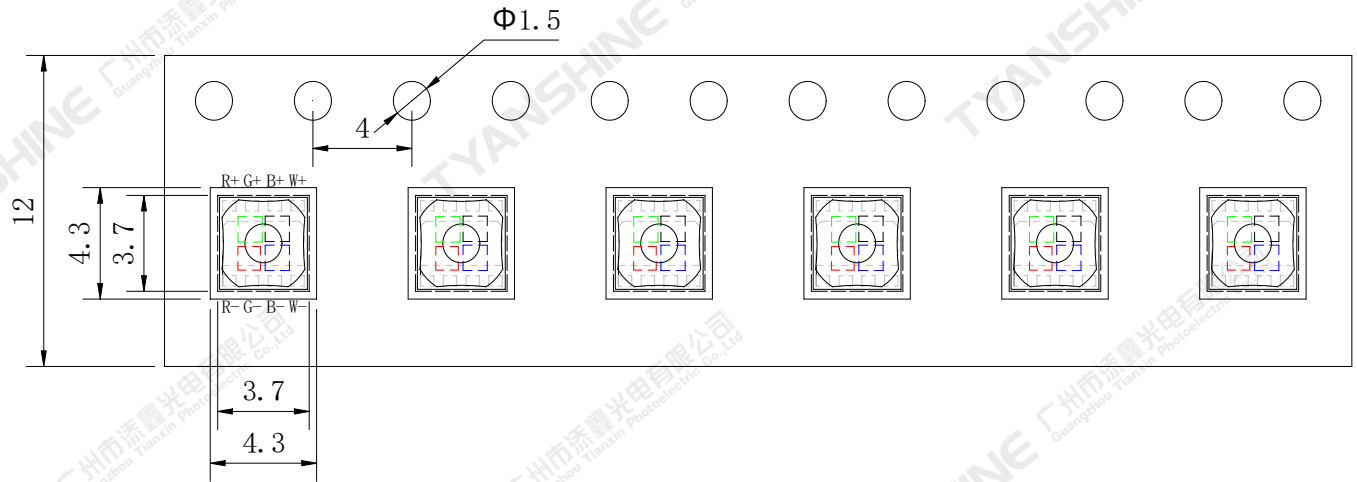

Notes:

1. All dimensions are in millimeters.
2. Tolerances are ± 2.0 mm unless otherwise noted.
3. The products are packaged together with silica gel, Transport, not to the weight of welding LED light-emitting area, As a result of the weight of LED light-emitting zone in the quality of, Irresponsible of the Company.

Part No.	TX-3535RGBW10VSD1-NG4DC-01H80	Spec No.	WKF-ED0151	Page	9 of 10
----------	-------------------------------	----------	------------	------	---------

